



SINCE 1985

LIGHTING & ELECTRICAL
PRODUCTS MANUFACTURERS

BREBASE Bollard Retrofit Base

✓ **BOLLARD
TROUBLE?**

✓ **NEED AN
UPGRADE?**

✓ **NEED IT TO
BE SIMPLE?**

- **Install new bollards to most existing bolt patterns**
- **No need to remove existing bolts**
- **Provides a clean finished appearance**
- **Hides ugly remnants of previous installation**
- **Fits most 3-bolt or 4-bolt patterns**
- **Fits all round and square QSSI bollards**

Simple Installations, Simple Retrofits



(Base Plate)



(Cover with
Bollard Anchorage)

- **Heavy-duty die cast aluminum with durable powdercoat finish**
- **Includes two leveling bubbles and four Stainless Steel leveling bolts**
- **Fits most existing bolt circles from 3.5" to 5", also accommodates field installed drilled anchors**
- **Available in Bronze, Black and custom colors**

Simply, the BREBASE!

12802 Commodity PL • Tampa, FL 33626 • www.qssi.com • Phone: 813-855-9416

Anchor Bolt Retrofit Adapter Plate

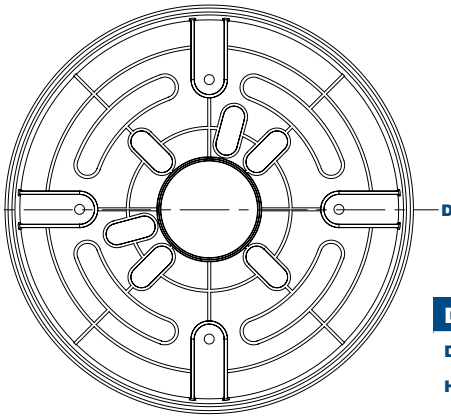

Dimensions

Diameter (D)	10¾" (271mm)
Height (A)	1" (26mm)



Bollard Mounting Cover Plate

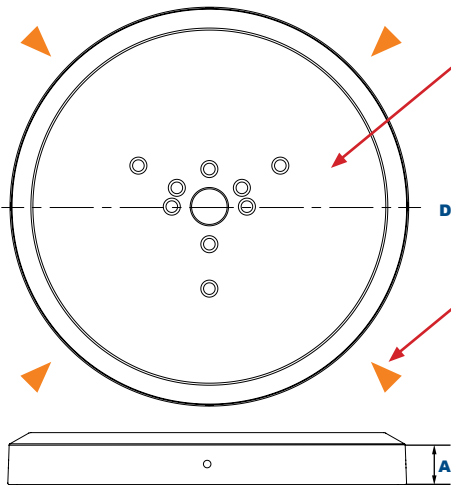
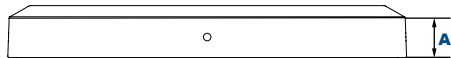

Plate has threaded holes in patterns for each QSSI bollard size. Mounting bolts are included. Bollard base mounts to plate.

Plate includes 4 set screws on sides at 90 degrees for locking base cover to mounting plate. Fully rotatable.

Dimensions

Diameter (D)	11½" (292mm)
Height (A)	1½" (38mm)



Anchor Bolt Retrofit Adapter Plate allows for mounting with field installed drilled anchors

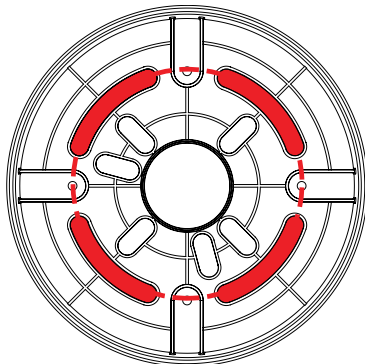

6.5" bolt circle for Drilled Anchors. Used when existing anchor bolts do not fit 4-bolt or 3-bolt slots or are damaged. These must be cut off and new drilled anchors installed.

Anchor Bolt Retrofit Adapter Plate Includes 4 leveling bolts and levels

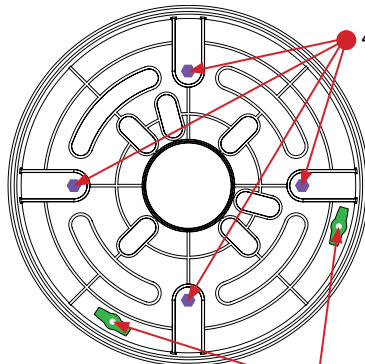

4 Leveling Bolts

Leveling Bubbles

BREBASE Bollard Retrofit Base Kit

Bollard Retrofit Base Kit includes:

- Heavy duty die cast aluminum Anchor Bolt Retrofit Adaptor Plate
- Includes slots for existing anchor bolt mounting, 3@120°, 4@90° or 2@180° (3.5" to 5" diameter bolt circle). Slots can accommodate ¼" to ¾" diameter anchor bolts.
- Includes large diameter slots for installing field drilled anchors (not included) in the event that the existing anchor bolt pattern does not fit slots, or anchor bolts are damaged or unusable.
- Includes 4 Stainless Steel leveling bolts with two leveling bubbles at 90° to level base prior to mounting new bollard.
- Center conduit entrance hole designed to accommodate two ¾" PVC conduits.

Heavy duty die cast aluminum Bollard Mounting Cover Plate

- Includes threaded holes in patterns to match all round and square QSSI bollard base mounting plates.
- Stainless Steel bolts for mounting bollard base plate.
- 4 Stainless Steel set screws at 90° for securing the cover plate to the adaptor plate. Cover plate can be rotated 360°.

Powdercoat finish over chromate conversion coating in Black or Bronze standard to match QSSI Bollards.

Anchor Bolt Retrofit Adapter Plate Bolt Circles for use with existing anchor bolts.

Conduit Entrance Area Accommodates Two ¾" Stub-Ups.

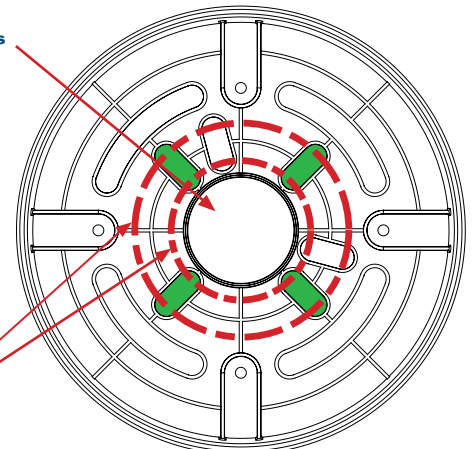

Fits bolt circles from 3.5" to 5"

For use with 4 bolts @ 90° or 2 bolts @ 180°

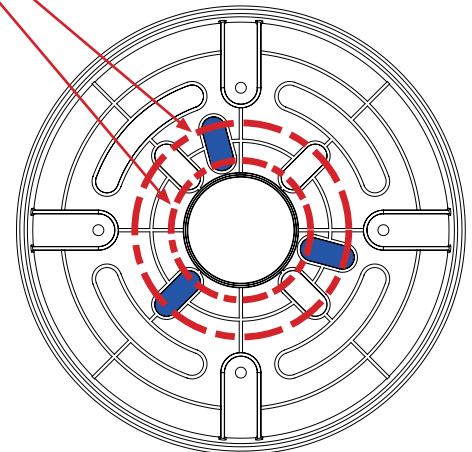

For use with 3 bolts @ 120°